













ALUMINIUM PROFILE & ABDECKUNGEN ALUMINIUM PROFILES & COVERS	
 <p>LIAP001004 Aluminium Profil LBU Aluminium profile LBU</p>	 <p>LIAB001100 Aluminium Abdeckung LB Aluminium cover LB</p>

PROFIL ABDECKUNGEN UND EINSCHÜBE PROFILE COVERS AND INSETS		
<p>$\eta \approx 88\%$</p>  <p>LIAB001001 PMMA Abdeckung LB Flach Transparent PMMA cover LB flat transparent</p>	<p>$\eta \approx 66\%$</p>  <p>LIAB001003 PMMA Abdeckung LB Flach Opal PMMA cover LB flat milky</p>	<p>$\eta \approx 84\%$</p>  <p>LIAB001010 PMMA Abdeckung LB engstrahlend - Abstrahlwinkel 64° PMMA cover LB narrow beam - beam angle 64°</p>
<p>$\eta \approx 72\%$</p>  <p>LIAB001006 PMMA Abdeckung LB Rund opal PMMA cover LB round milky</p>	<p>$\eta \approx 77\%$</p>  <p>LIAB001009 PMMA Abdeckung LB Eckig Opal PMMA cover LB square milky</p>	<p>$\eta \approx 83\%$</p>  <p>LIAB001011 PMMA Abdeckung LB asymmetrisch - Abstrahlwinkel 73° PMMA cover LB asymmetrical - beam angle 73°</p>

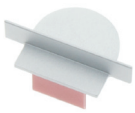
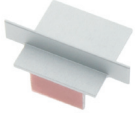
PROFIL ENDKAPPEN PROFILE ENDCAPS		
<p>Endkappenstärke End cap thickness 1,0mm</p>  <p>LIEK001400 Profil Endkappe LBU Flach geschlossen Profile endcap LBU flat closed</p>	<p>Endkappenstärke End cap thickness 1,0mm</p>  <p>LIEK001410 Profil Endkappe LBU Rund geschlossen Profile endcap LBU round closed</p>	<p>Endkappenstärke End cap thickness 1,0mm</p>  <p>LIEK001420 Profil Endkappe LBU Eckig geschlossen Profile endcap LBU square closed</p>
<p>Endkappenstärke End cap thickness 1,0mm</p>  <p>LIEK001401 Profil Endkappe LBU Flach mit Langloch Profile endcap LBU flat with cable entry</p>	<p>Endkappenstärke End cap thickness 1,0mm</p>  <p>LIEK001411 Profil Endkappe LBU Rund mit Langloch Profile endcap LBU round with cable entry</p>	<p>Endkappenstärke End cap thickness 1,0mm</p>  <p>LIEK001421 Profil Endkappe LBU Eckig mit Langloch Profile endcap LBU square with cable entry</p>

- 1m
- 2m
- 4m
- SONDER LÄNGE
- SPECIAL LENGTH

STANDARDLÄNGE = 2M | ALLE ANDEREN LÄNGEN SIND VOM UMTAUSCH UND DER RÜCKGABE AUSGESCHLOSSEN. LÄNGEN ÜBER 2M WERDEN MITTELS SPEDITION VERSENDET UND ERFORDERN EINE MINDESTBESTELLMENGE VON 10 STK.

STANDARD LENGTH = 2M | ALL OTHER LENGTHS ARE EXCLUDED FROM EXCHANGE AND RETURN. LENGTHS OVER 2M ARE SHIPPED BY FREIGHT CARRIER AND REQUIRE A MINIMUM ORDER QUANTITY OF 10 PCS.

HINWEIS
PLEASE NOTE

Kunststoff und Aluminium besitzen unterschiedliche Ausdehnungskoeffizienten, welche bei der Montage zu berücksichtigen sind. Ausgehend von 20°C verändert sich die Länge beim Aluminium um ca. 0,25mm pro Meter und beim Kunststoff um ca. 0,70mm pro Meter je 10°C Temperaturunterschied.

Plastic and aluminium have different expansion coefficients, which must be considered during assembly. Based on 20°C the length of aluminium changes approximately 0,25mm per meter and plastic approximately 0,70 mm per meter per 10°C of difference in temperature.